

BIGAB®

HOOK LIFT SYSTEM

 FORSMW



www.forsmw.com



BIGAB COLLECTION



Contents

BIGAB 7–10 / 8–12.....	3
BIGAB 10–14 / 12–15 / 14–17.....	4
BIGAB 15–19 / 15–19T / 17–20	6
BIGAB B20	8
BIGAB 22–27.....	10
BIGAB Z-Cranes	11
BIGAB Dump Trailers	12
Equipment	14
Containers.....	16
Wheels.....	17
Technical data.....	18

For information on optional equipment, please see the end of the brochure.

Please note that this catalogue is valid only for the specified country. In this catalogue we reserve the right to revise specifications without prior notice.

All images are for illustrative purposes only.

Adoption of national, regional or local requirements beyond CE-approval or equivalent is not the responsibility of the manufacturer. Weights and data refer to the technical capacity of the equipment in ideal situations. Local regulations must be taken into account.

Introduction

BIGAB hook lift system is a Swedish original product developed in Sweden more than 45 years ago. Göte Håkansson is the man behind BIGAB.

Göte says, “the idea for a hook lift had been growing within me for a long time. I saw the trailers that the farmers used back then. Trailers which, due to their inflexibility, were only used a few days a year, out of a financial perspective, it did not seem like a smart investment. The trailers were never torn down and the tires dried because the trailers were

never used. The first BIGAB was the BIGAB 15 – 19, a faithful servant still in production as of today”.

25 years after the construction of the first hook lift, production was moved from Sweden to Estonia. It did not take long before what was previously produced in a year, came to be delivered over a two-week period, and so it continues to this day 20 years later in the same factory.

BIGAB hook lift systems are today Europe’s best-selling hook lifts. For more than 40 years, BIGAB has proven its high quality and been the customers’ favourite. Our long experience of hook lift systems, refined with the views

and wishes of our customers, has made us the best in the industry at what we do. The BIGAB product range consists today of hook lifts, Z-cranes, dump trailers and containers.

BIGAB has been part of the FORS MW Group since 1999 together with the forest brand FARMA. Fors MW always strives to be at the forefront of development - this is how we can offer the best combination of well-thought-out design solutions, high quality and attractive prices.





7-10

BIGAB 7-10 is a strong, stable but light and easily manoeuvrable trailer. Its versatility and strength make it the perfect choice for users who require trailer for lighter loads and tighter spaces such as working in residential areas, parks etc. It is one our best selling models.



Standard equipment	
Mechanical pendulum bogie	Back lights – LED
Drum brakes on 2 axles – Hydraulic	Parking leg – Manual
Drawbar – Height adjustable	Hooking tower – Fixed
Frame/bogie block – Hydraulic	Container lock – Mechanical

Option suggestion		
Different toolboxes	Frame steering	Tyre options
		

Option photos are only for illustrative purposes.

	7-10	8-12
Wheel dimension	400/60-15,5	400/60-15,5
Required tractor hydraulics	1 brake outlet: 2 double action	1 brake outlet: 2 double action
Max hooking capacity (kg)	7 000	8 000
Max tipping capacity (kg)	8 000	10 000
Suitable container length (mm)	4 150–4 600	4 150–4 600
Chassis weight: Standard equipment (kg)	2 000	2 200

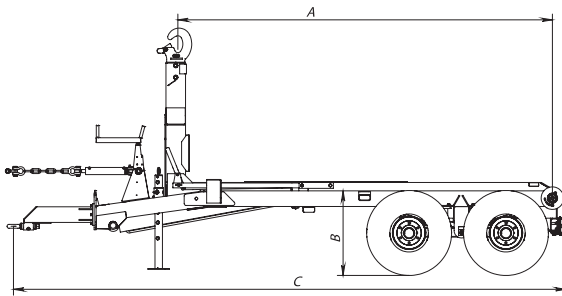

	A (mm)	B (mm)	C (mm)
7-10	3 830	860	5 655
8-12	3 830	895	5 680

Principle sketch - not to scale.

8-12

BIGAB 8-12 with its 40 years in service is a faithful servant indeed. It is light and versatile but has a strong frame and greater load capacity than the 7-10 model. Excellent for using together with wheel excavators, when a strong frame is required.



10-14

BIGAB 10-14 is the model which meets the quality and the demands of the professional operator. Even though extremely flexible, because of its design, this trailer has maximum strength and rigidity. It remains completely stable during both tipping and exchange operations. The 10-14 model is recommended when several different drivers work with the same unit. Thanks to the fixed tower and simple design, the trailer is reliable and easy to operate.



Bestseller!

12-15

**Z-Crane,
see page 11!**



BIGAB 12-15 has a foldable tower to enable greater exchange capability and a reduced pulling angle. This is the perfect choice when a flexible trailer with extra container exchange and loading capability is required. This model is used in a wide variety of areas from agriculture, energy, garbage disposal to installation and construction work.

Option suggestion

Mudguards



Electric control valve



Double action outlets on the tower



Option photos are only for illustrative purposes.

Standard equipment

Drum brakes on 2 axle (Hydraulic)

Drawbar – Adjustable

Frame lock – Hydraulic

Back lights – LED

10-14	12-15	14-17
Mechanical pendulum bogie	Mechanical pendulum bogie	Sprung pendulum bogie
Parking leg - Manual	Parking leg - Manual	Parking leg - Hydraulic
Hooking tower - Fixed	Hooking tower - Foldable	Hooking tower - Foldable
Bogie block - Hydraulic	Bogie block - Hydraulic	Tipping/hooking - Hydraulic
		El. on/off valve 4 functions

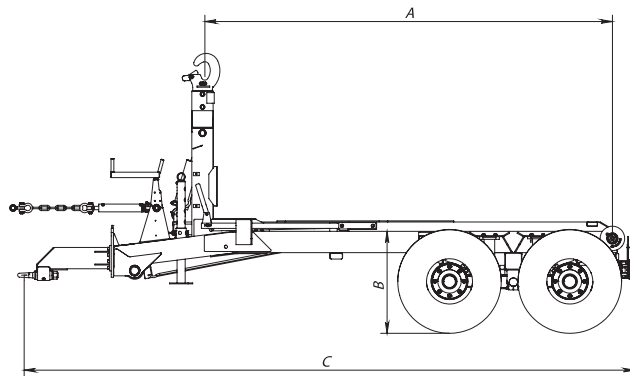

	A (mm)	B (mm)	C (mm)
10-14	3 830	930	5 740
12-15	3 830	930	5 740
14-17	3 830	920	5 740

Principle sketch - not to scale.

	10-14	12-15	14-17
Wheel dimension	500/50-17	500/50-17	500/50-17
Required tractor hydraulics	1 brake outlet: 2 double action	1 brake outlet: 3 double action	1 brake outlet, Electric control valve, pressure and free return
Max hooking capacity (kg)	10 000	12 000	14 000
Max tipping capacity (kg)	12 000	13 000	14 000
Suitable container length (mm)	4 150-4 600	4 150-4 600	4 150-4 600
Chassis weight: Standard equipment (kg)	2 300	2 600	2 900

12-15



14-17



BIGAB 14-17 is basically the same as the 12-15 but is the perfect choice if you require a fully equipped variant, offering excellent return on your investment. This trailer is the obvious choice for transporting heavy loads over long distances; it is a trailer that rides well even on the poorest of roads.



15-19

Popular choice

Standard equipment

Two hydraulic outlets on the tower	Frame lock – Hydraulic
Drum brakes on 2 axles – Hydraulic	Back lights – LED
Drawbar – Adjustable	

15-19	15-19T	17-20
Mechanical pendulum bogie	Mechanical pendulum bogie	Tandem parabolic bogie
Tipping/hooking – Mechanical	Tipping/hooking – Hydraulic	Tipping/hooking – Hydraulic
Hooking Tower – Foldable	Hooking Tower – Telescopic	Hooking Tower – Foldable
Bogie block – Hydraulic	Bogie block – Hydraulic	Mudguards – Front/rear
Parking leg – Manual	Parking leg – Manual	ON/OFF Valve Functions
	Container lock – Hydraulic	
	EFC 4 functions	

15-19

BIGAB 15-19 is our faithful servant and continues to be one of our most popular models with huge numbers of satisfied customers. Its areas of use are numerous, ranging for agriculture, large industries and waste disposal to installation and construction work. This variant is perfect for those requiring a large trailer for a variety of transportation needs. This model can be compatible with truck style containers. A foldable tower and a strong frame combined with a simple design provide it with high capacity and excellent reliability. Extra equipment and a choice of tyres are available. It is designed for 5 500-6 000 mm container length.



15-19T

BIGAB 15-19 T is a flexible and versatile trailer. The exchange system is built with a telescopic tower which allows handling container lengths from 4 600-6 000 mm. The 15-19 T is now taking a step up and becomes the reliable link between our smaller BIGAB models and larger. A hooklift that can combine both short containers for contracting work as well as longer ones for agricultural and trucking.

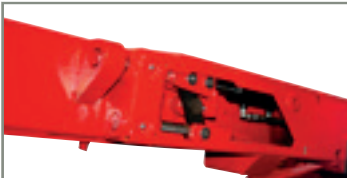

15-19T

Option suggestion

Hydraulic control tipping/exchange	Suspension
	

Option photos are only for illustrative purposes.

17-20

BIGAB 17-20 is a model with the same basic design as the 15-19 but which is fully equipped, most of the equipment being fitted as standard at the factory. BIGAB 17-20 is the perfect choice when a fully equipped, high specification trailer is required.

17-20

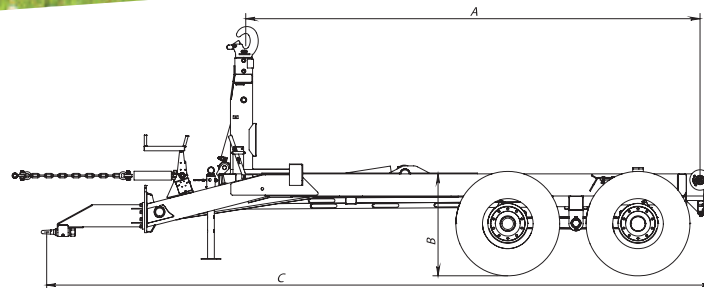

	A (mm)	B (mm)	C (mm)
15-19	5 130	1 150	7 520
15-19T	5 505	1 170	7 510
17-20	5 130	1 150	7 520

Principle sketch - not to scale.

	15-19	15-19T	17-20
Wheel dimension	500/50-17	500/50-17	600/50-22,5
Required tractor hydraulics	3 double action 1 brake outlet	1 brake outlet, 1 double action EFC	1 brake outlet, Electric control valve, pressure and free return
Max hooking capacity (kg)	16 000	16 000	17 000
Max tipping capacity (kg)	16 000	16 000	17 000
Suitable container length (mm)	5 500-6 000	4 600-6 500	5 500-6 000
Chassis weight: Standard equipment (kg)	4 100	4 380	4 500

Option suggestion

Steering axle



Z-Crane

For more information,
see page 11.



Option photos are only for
illustrative purposes.



B20

New!

B20

Introducing the next Generation of BIGAB we do so proud and humble of our fantastic history with more than 8 000 hook lift trailers at market worldwide. With refined functions, ingenious solutions and user-friendly details we present the future of hook lifts.

BIGAB B20 is the hook lift for those with heavy-duty transportation needs. Its many areas of use range from, for example, grit and sand transportation to crop harvesting. B20 is a robust and durable hook lift, built to be used. This model can be compatible with truck style containers.

Through its modular and flexible construction, the trailer can quickly be adapted to the needs of its customer. It is easy to retrofit various accessories which makes the exchange of parts simpler and less expensive throughout the life cycle of the trailer.

- **BIGAB B20 is 15% faster in the operational cycle.** This has been achieved through a new geometry that provides maintained performance with lower oil consumption.
- **BIGAB B20 handles containers in lengths of 5.0-6.5 meters and has a tipping angle of up to 55-58 degrees, depending on whether you equip the hook lift with a hydraulic suspended drawbar or not.**

B20

Wheel dimension in standard	560/60-22,5	Max tipping capacity (kg)	20 500
Required tractor hydraulics	1 brake outlet, Electric control valve, pressure and free return	Suitable container length (mm)	5 000–6 500
Max hooking capacity (kg)	20 500	Chassis weight: Standard equipment (kg)	4 520

The BIGAB B20 has a completely new list of accessories, developed specifically for the new series:

INCLUDED IN STANDARD

New bogie block: The BIGAB B20 has been fitted with a further developed bogie block that is activated over the rear axle and locks the movements of the hook lift when hooking. Together with the standard-fitted weight transfer cylinder that is attached to the tractor's top link bracket, the bogie block helps to prevent the tractor from lifting when hooking. Through this we get a very safe shifting manoeuvre throughout the process.

INCLUDED IN STANDARD

New lock between tip and hooking: The new Tip/hooking lock is activated by moving the tower to its rearmost position. The construction has become more powerful than before and also saves a hydraulic function through that the tower telescope activates the lock.

OPTIONAL ACCESSORY

The hydraulic drawbar: The hydro active drawbar we've already mentioned, but besides increasing the tipping angle by 3 degrees, its hydraulically sprung drawbar offers an entirely different comfort while driving the trailer.



B20

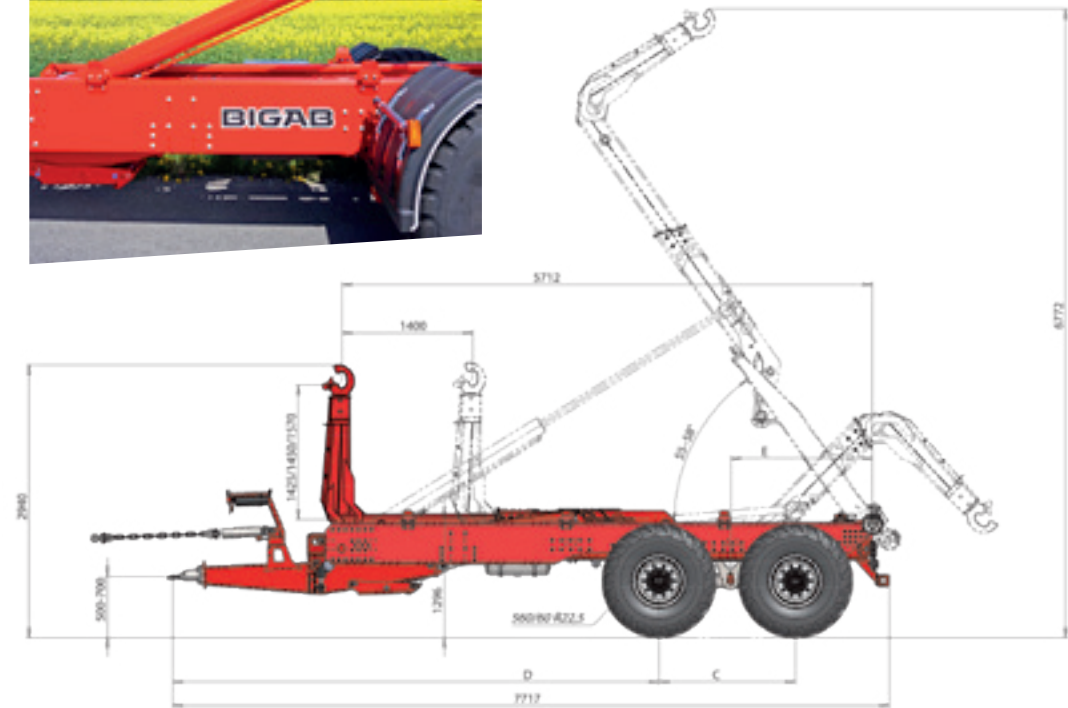

Principle sketch - not to scale.

Bogie type	A (mm)	B* (mm)	C (mm)	D (mm)	E (mm)
Bogie	1 893	2 448	1 470	5 237	1 529
Tandem suspension	2 000	2 550	1 525	5 032	1 735
Tandem long	2 000	2 550	1 812	4 883	1 740
Air	2 000	2 550	1 810	4 880	1 742

*Wheels: 560R60-22,5

22-27



22-27

Are you in need of a larger trailer that can cope with continual hard work but which treats loads carefully? BIGAB 22-27 is perfect for you. This is a trailer that can be driven on public roads fully loaded but which makes very little impression on sensitive ground. The drawbar attachment is hydraulically sprung with an accumulator. If necessary the load can be transferred from the trailer to the tractor's drawbar. The steered axles are controlled from the tractor via a double-action outlet with floating position. BIGAB 22-27 is well equipped as standard.

	A (mm)	B (mm)	C (mm)
22-27	5 620	1 330	7 710

Principle sketch - not to scale.

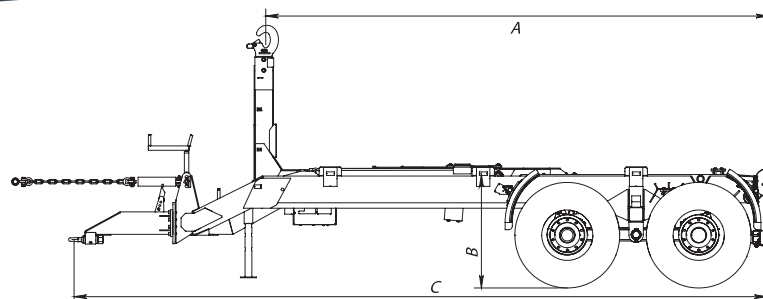

Standard equipment 22-27	
Tipping/hooking – Hydraulic	Tridem parabolic suspension
Double action outlets on the tower	Drum brakes on 3 axle (Hydraulic)
Hooking Tower – Telescopic	Drawbar – Suspended
Mudguards - Front/rear	Container lock – Hydraulical
Frame lock – Hydraulical	ON/OFF Valve 6 Functions
Back lights – LED	

22-27	
Wheel dimension	560/60-22,5
Required tractor hydraulics	1 brake outlet, Electric control valve, pressure and free return with one double action with floating position for steering
Max hooking capacity (kg)	21 000
Max tipping capacity (kg)	22 000
Suitable container length (mm)	4 800–6 500
Chassis weight: Standard equipment (kg)	6 600

Option suggestion

Long suspension



Z-Crane

For more information, see page 11.



Airbrakes



Option photos are only for illustrative purposes.

BIGAB®

Z-CRANE



6.6Z

8.0Z



	Z 6,6	Z 8,0
Reach (m)	6,6	8
Slewing angle (°)	380	380
Telescopic stroke length (m)	1,45	2,65
Weight incl. grapple bucket 160 L/ Weight of crane (kg)	1 012/820	1 062/870
Weight incl. grapple bucket 200 L/ Weight of crane (kg)	1 022/820	1 072/870
Weight incl. grapple 0,20*/ Weight of crane (kg)	952/820	1 000/870
Lifting force full length (excl. grapple/rotator) (kg)	750	590

*The weights include grapple, rotator and link

BIGAB Z-crane range offers cranes with the reach from 6,6 to 8 m. In transport mode, the crane is folded in a parking position in front of the tower and the trailer can be used without any interruption of the crane.

Option suggestion

Grapple buckets



Grapples



Radio controlled



Z-CRANE

10-14 ✓

12-15 ✓

14-17 ✓

15-19 ✓

17-20 ✓

B20 ✓

22-27 ✓

BIGAB[®]

DUMP TRAILER

BT-8

BT-10



Standard equipment

Drawbar – Adjustable

Manual parking leg

Rear underrun protection

Back lights – LED

Slow moving vehicle sign

Combi door

Adjustable bogie

Option suggestion

Hydraulic tailgate



Combi door tailgate



Mechanical lifting tailgate
(Only for BT-8)



BIGAB dump trailer is an unique trailer on the market to offer easily adjustable bogie position to adjust drawbar load. It is adapted for wheeled excavators and tractors. The chassis is made of high strength steel and container body is made of wear resistant steel that makes the trailer strong but light.

After BT-8's huge success on the market induced an idea for bigger dump trailer. Most visible difference between these two trailers is the container size. The volume is 55% bigger for BT-10 compared to BT-8. Besides the sizes there is also difference in material: BT-10 is made of thicker Hard Wear steel. It also has bigger wheels for higher ground clearance. All this has added extra value for the end user.

Dump trailers are available from 8 tons up to 10 tons with the load capacity of 4 to 6,2 m³.



Option suggestion

Frame steering



Sidelights



Headboard extension



Tyre options



	BT-8	BT-10
Wheel dimension	400/60-15,5	500/50-17
Required tractor hydraulics	1 outlet	1 outlet
Chassis weight: Standard equipment (kg)	1 815	2 550
Load capacity (m ³)	4	6,2
Max. payload (kg)	8 000	10 000
Total weight with load (kg)	9 815	12 500
Tipping angle (°)	60	60
Internal dimensions of load surface (mm)	3 670x2 200x500	4 090x2 205x685

Principle sketch -
not to scale.

BT-8

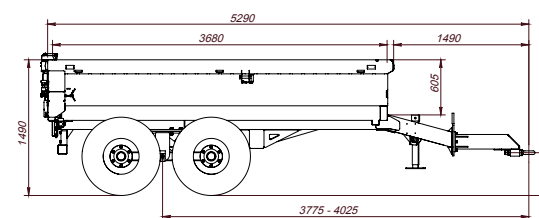

BT-10

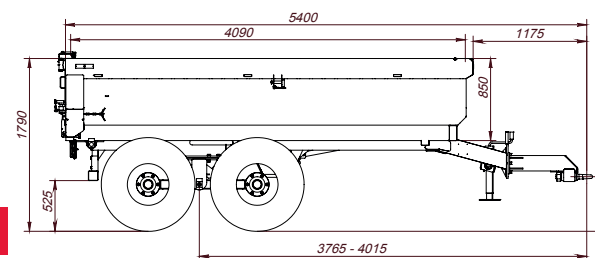

Option photos are only for
illustrative purposes.

Equipment

DRAWBAR



Various drawbar solutions for customer and legal requirements.

BRAKES EQUIPMENT



BIGAB offers several types of brakes to suit an intended towing vehicle. We can provide hydraulic brakes, pneumatic brakes (positive/Tristop system) and a combination of the two.

REAR TOWING COUPLING



BIGAB offers a variety of towing couplings for both front and rear mounting, all adapted to suit customer particular needs.

HYDRAULIC CONTROL TIPPING/EXCHANGE

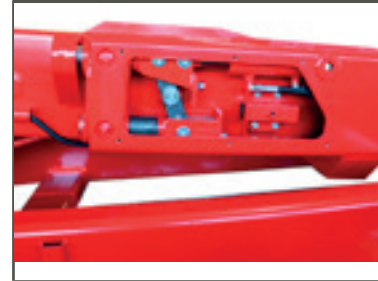

We can also provide hydraulic control between tipping and exchange for the models that do not have this as standard equipment. An alternative for those who would like to select tipping or exchange from the cab.

PARKING LEG



Three types of parking legs are available. A basic solution comprising a rigid leg with pin holes for various height settings for use when the tractor has a lift drawbar, a hydraulic leg operated via a single-action hydraulic outlet and a crank adjustable leg when there is a need to adjust the height to suit the towing vehicle.

CONTAINER LOCK



BIGAB provides mechanical container locks as standard equipment but can also provide hydraulic locks to lock the container onto the frame. A hydraulic container lock is shown on the photo.

REAR LIGHTS



BIGAB provides lighting according to the respective country's legislation as standard equipment. If regulation permits, extra tail lights, number plate lights and a reversing signal can be fitted.

CHOICE OF ELECTRIC VALVE



In order to reduce the number of hoses to the tractor, BIGAB offers a range of in cab electric control valve options along with load sensing.

TOOLBOX



Toolbox is available in plastic or stainless steel, both options are lockable with key.

MUDGUARDS



If you would like your trailer fitted with complete or half mudguards, we have various models to choose from depending on trailer variant and wheels. Mudguards help keep the trailer clean particularly when driving without a container since a container bridge helps reduce splash.

FRAME STEERING



BIGAB can be equipped with a frame steered drawbar. Very useful when turning in limited spaces or even more so when reversing in tight spaces. Frame steering also makes it easier when reversing in order to pick up a container.

SIDE LIGHT



Various side light options for customer and legal requirements are available.

POWER-STEERED AXLES



BIGAB can also provide power-steered axles with hydraulic cylinders that sense the movement of the tractor automatically. Especially beneficial when precise steering of the trailer is required. The equipment requires a tractor adapted for the purpose.

SUSPENSION OPTIONS



BIGAB trailers can be equipped with a sprung bogie for increased comfort when driving on uneven terrain, particularly at high speed, to the benefit of both driver and machine. Long suspension with the bigger wheel centre's gap is also available.

DOUBLE-ACTION HYDRAULIC OUTLET ON THE TOWER



Suitable equipment for use with a container with a hydraulic tailgate if you want to operate the tailgate when the container is removed from the trailer. The hoses go with the container down onto the ground, and make it possible, for example, to drive on a mini digger, close the tailgate and reload the container.

SUSPENDED DRAWBAR



We can provide a suspended drawbar to increase comfort when driving. This improves driving comfort by absorbing shocks transmitted from the trailer. BIGAB 22-27 includes this as standard equipment, but it is also available as an option on most models.

STEERED AXLES



Follow-steered or powersteered axles can be fitted to BIGAB units that have suspension. This reduces both tyre wear and disturbance of the ground. It also reduces the amount of pulling power required.

REAR UNDERRUN PROTECTION



For the road safety we offer manually, hydraulically adjustable and fixed rear underrun protection.

BIGAB®

HOOK LIFT SYSTEM

Containers

BIGAB offers a great range of containers from sizes 4,1 m up to 6 m for your everyday work. Our bestseller is the Hardox container, HSS, a container designed for hard and demanding work. It is built entirely in high strength steel, which makes the body more durable and more wear resistant. This container has combi door with hydraulic tailgate.

BIGAB 7-10, 10-14, 10-14 G2, 12-15, 12-15 G2, 14-17, 15-19T*					
	Part nr	Name	External measurements	Internal measurements	Weight kg
Containers with combi doors	700230	container with combi doors	4 150 x 2 550 x 700, B=6, S=4	4 030 x 2 420 x 695	1 400
	700233	container with combi doors	4 150 x 2 300 x 500, B=6, S=4	4 030 x 2 180 x 495	1 200
	700233-1	container combi doors, special	4 150 x 2 300 x 700, B=6, S=4	4 030 x 2 180 x 695	1 300
	700237*	container with combi doors	4 600 x 2 550 x 500, B=6, S=4	4 480 x 2 420 x 495	1 550
	700237-1*	container combi doors, special	4 600 x 2 550 x 700, B=6, S=4	4 480 x 2 420 x 695	1 650
Containers with hydraulic tailgate	700231-HSS	container with hyd-tailgate	4 150 x 2 550 x 700, B=6, S=4	4 030 x 2 420 x 695	1 500
	700232	container with hyd-tailgate	4 150 x 2 300 x 500, B=6, S=4	4 030 x 2 180 x 495	1 300
	700232-1	container hyd-tailgate, special	4 150 x 2 300 x 700 B=6, S=4	4 030 x 2 180 x 695	1 400
Containers with 2 side hanging doors	700234	container with side hanging doors	4 150 x 2 300 x 1 400	4 030 x 2 180 x 1 395	1 300
	700238*	container with side handing doors	4 600 x 2 500 x 1 400, B=4, S=3	4 480 x 2 370 x 1 395	1 560
	700239*	container with side handing doors	4 600 x 2 500 x 2 000, B=4, S=3	4 480 x 2 370 x 1 995	1 800
Container/ flat bed wooden plates on bottom	700236*	container protection of wood, wooden plates on bottom	No sides 4 600 x 2 550, B = 6.		1 700
Drop side containers	700235	container with folding sides and tailgate	4 500 x 2 450 x 460, B=4, S=3	4 380 x 2 320 x 455	1 640
	700235-1	container with folding sides, special	4 500 x 2 450x (2*460), B=4, S=3	4 380 x 2 320 x 910	1 790
Load carrier frame	700244	Load carrier frame	L = 4 500	4 500 x 1 060 x 1 450	330

*15-19T Can take containers 4 600-6 500 mm.

BIGAB 15-19, 15-19T, 17-20, 20-24**, B20, 22-27**					
	Part nr	Name	External measurements	Internal measurements	Weight kg
Containers with combi doors	700240	container with combi doors	5 500 x 2 500 x 700, B=6, S=4	5 380 x 2 370 x 695	2 000
	700243	container with combi doors	6 000 x 2 550 x 1 000, B=6, S=4	5 880 x 2 420 x 995	2 300
Containers with hydraulic tailgate	700241	container with hyd-tailgate	5 500 x 2 500 x 700, B=8, S=6	5 380 x 2 370 x 695	2 550
	700242	container with hyd-tailgate	6 000 x 2 550 x 800, B=8, S=6	5 880 x 2 420 x 795	2 760
Load carrier frame	700245	Load carrier frame	L = 6 000	6 000 x 1 060 x 1 450	660

**20-24 and 22-27 can take containers 4 600-6 500.



Container with combi door



Container with hydraulic tailgate



Container with 2 side hanging doors



Drop side container

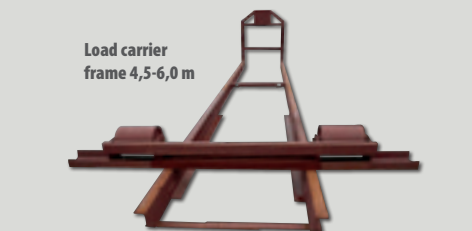

Load carrier frame 4,5-6,0 m



Flat bed

Wheels

Part number	Name	7-10 8-12	10-14 14-17	15-19	17-20	B20	22-27	BT-8 dump	BT-10 dump	Tyre type
916513	Wheel 385/65R-22,5 10B/0			OPTION	OPTION	OPTION	OPTION			A
916515	Wheel 400/60-15,5 B6/-15	STANDARD						STANDARD		A
9165258	Wheel 435/50R-19,5 8B/0		OPTION							D
916527	Wheel 445/65R-22,5 10B/0			OPTION	OPTION	OPTION	OPTION			D
916528	Wheel 19/45-17 6B/-70	OPTION						OPTION		A
916529	Wheel 500/50-17 8B/0		STANDARD							A
916530	Wheel 500/50R-17 8B/0		OPTION							A
916535-35	Wheel 500/50-17 TL 18PR 6B/-35								STANDARD	A
916540L&R	Wheel 500/60-22,5 10B/-15			STANDARD						B
916563L&R	Wheel 560/60-22,5 10B/0 CntKing				OPTION	OPTION	OPTION			C
916566L&R	Wheel 560/60-22,5 10B/-50 CntKing			OPTION						C
916566L-1&R-1	Wheel 560/60R-22,5 10B/-50 BKT			OPTION						C
916563L-1&R-1	Wheel 560/60R-22,5 10B/-15 BKT				OPTION	OPTION	STANDARD			C
916546L&R	Wheel 600/50R-22,5 TL 10B/0 NOKIA				OPTION					B
916545L&R	Wheel 600/50R-22,5 TL 10B/-70 NOKIA			OPTION		OPTION				B
916545L-1&R-1	Wheel 600/50-22,5 TL 10B/-70 BKT			OPTION						B
916546L-1&R-1	Wheel 600/50-22,5 TL 10B/0 BKT				STANDARD					B
916548L&R	Wheel 650/50R-22,5 TL 10B/-70 CntKing						OPTION			C

Tyre type



A



B



C



D

The pictures are just examples.

Technical data

	7-10	8-12	10-14	12-15	14-17	15-19	15-19T	17-20	B20	22-27
Wheel dimension in standard	400/60-15,5	400/60-15,5	500/50-17	500/50-17	500/50-17	500/60-22,5	500/60-22,5	600/50-22,5	560/60-22,5	560/60-22,5
Width across the wheels (mm) with standard equipment*	2 100	2 100	2 300	2 300	2 400	2 450	2 450	2 630	Depends of undercarriage and wheels	2 690
Chassis length (with drawbar) (mm) with standard drawbar	5 700	5 700	5 700	5 700	5 700	7 300	7 506	7 300	7 770	7 550
Total weight (kg)	Country dependent									
Chassis weight: standard equipment (kg)	2 000	2 200	2 300	2 600	2 900	4 100	4 380	4 500	4 520	6 600
Max hooking capacity (kg)**	7 000	8 000	10 000	12 000	14 000	16 000	16 000	17 000	20 500	22 000
Max tipping capacity (kg)**	8 000	10 000	12 000	13 000	14 000	16 000	16 000	17 000	20 500	22 000
Required tractor hydraulics: 1 brake outlet	2 double action	2 double action	2 double action	3 double action	1 double action, electric control valve, pressure and free return	3 double action	1 double action, free return	1 double action, electric control valve, pressure and free return	3 double action, pressure and free return	1 double action, free return
Oil Volume: Minimum available oil, with full system (L)	6	8	8	10	10	18	22	19	23	23
Max working pressure (MPa)**	17	17	22	22	22	21	21	22	21	22
Tipping angle (°)	48	48	48	48	48	51	51	51	55-(58****)	51
Container length (mm)	4 150-4 600	4 150-4 600	4 150-4 600	4 150-4 600	4 150-4 600	5 500-6 000	4 600-6 500	5 500-6 500	5 000-6 500	4 800-6 500
Standard speed limit (km/h)***	Speed limit is up to specifications.									

More information about the technical data can be found here www.forsmw.com

* Note! Dimensions might change depending of specific configuration

** Max load cases when operating the hooklift system and tipping are stated.

*** Speed limit depends on local laws.

**** With suspended drawbar.

Numbers can be rounded off to the nearest whole number.

Weights and data refer to the technical capacity of the equipment in ideal situations. Local regulations must be taken into account.

Adoption of national, regional or local requirements beyond CE-approval or equivalent is not the responsibility of the manufacture.

We reserve the right to revise specifications without prior notice.



www.forsmw.com



NOTES

BIGAB®

HOOK LIFT SYSTEM

Dealer

www.creellam.com
EN-23-01

